

What's in this bag?

This kit contains detailed instructions with photographs, all components (over 40 parts), quality double sided circuit board, and theory of operation. You'll need a 9V battery, electronics grade soldering pencil, and some basic hand-tools to complete this project!

No prior knowledge of electronic fabrication required!

Evolving your CYBUG SCARAB

Check out these add-on circuit boards to enhance your scarabs behaviour...

HBF-1: Hunger Instinct

This higher brain function continually monitors the robots energy level and change it's behavior from photo-phobic (afraid of light) to photo-tropic (attracted to light) as necessary. When energy is low, your CYBUG will be drawn to the light of the SUNFLOWER for a meal, but once full, it must leave the watering hole for the safety of dark areas.

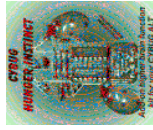

HBF-2: Predator Instinct

This *higher brain function* add on board for the CYBUG adds a keen sense to the basic platform which allows your robot to spot and chase any CYBUG (or other robot) which carries the transmitter board. The transmitter board (also in this kit) produces and infra-red digital *scent* which betrays the prey.

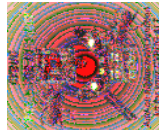

Other CYBUG kits...

Your Scarab will enjoy the company of our other robotic lifeforms including the new QueenAnt, Sunflower power plant (feeding station), and the Solarfly (solar powered). (each sold separately)

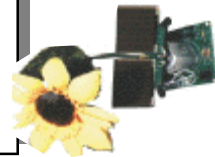

For questions or support please contact:

JCM Inventures (aka JCM Electronic Services)
 (403) 284-2876
<http://www.jcminventures.com>
info@jcminventures.com



Cybug Scarab

Artificial Lifeform

BIO-MECH ROBOT KIT

[HTTP://WWW.JCMINVENTURES.COM](http://www.jcminventures.com)

The **CYBUG SCARAB** is a new, exciting type of educational kit. It combines elements of electronics, robotics, mechanics, and biology in a unique and interesting form. It's instructional, very easy to build, and fun to modify and customize.

The operating CYBUG SCARAB behaves as a living organism, with behavior and instinct designed in it's circuitry. The robo-organism is nocturnal (most active at night) and can be configured to be photo-tropic (light seeking) or photo-phobic (light avoiding). A quick adjustment causes the Scarab to behave aggressively as a predator, or timid and slow moving like a herbivore. No two Scarabs are exactly the same and you will come to recognize the unique characteristics of each!

The Scarab is just one member of a new robotic ecosystem which parallels nature in a unique and fascinating manner while educating it's owners in fundamentals of electronics, robotics, biology, and control systems.

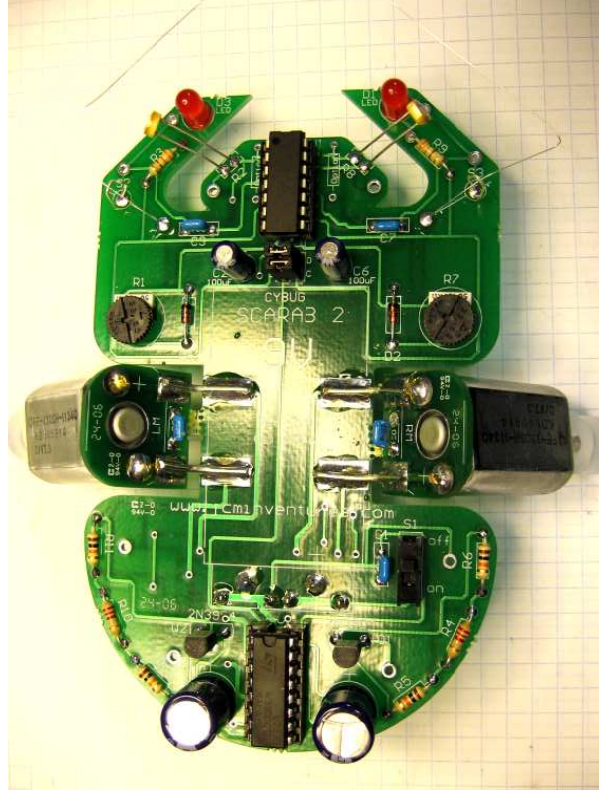



ASSEMBLY NOTES

Caution:

Building an electronic project is enjoyable, but please **resist the temptation to hurry ahead** and omit instruction steps. Please be sure that you:

- Read all instructions carefully.
- Read the entire step before you perform each operation.
- Be careful when handling a hot soldering iron. Tip temperature may approach 700° F.
- Make certain that you wear appropriate safety glasses at all times and work in a well ventilated area.
- When cutting wires, make sure that the cut end is directed away from everyone.
- Solder a part or group or parts only when you are instructed to do so.

Tools:

You will need these tools to assemble your kit.

- Wire Strippers
- Diagonal Cutters (Side Cutters)
- Long Nose Pliers
- Soldering Iron (25 to 40 Watts)
- Ruler (metric / imperial)
- Masking tape
- **Safety Glasses!**

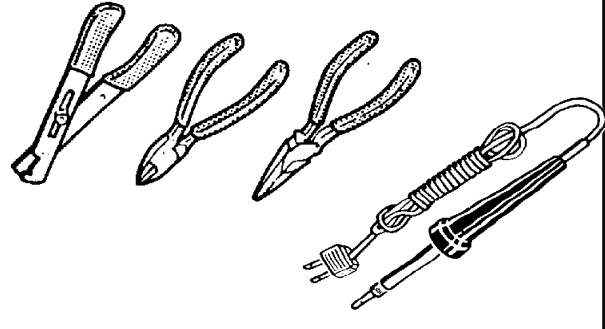

Please follow all instructions carefully, and be very careful that you **use safety glasses** at all times when building your kit! Be careful when handling your soldering iron... the tip is **very hot!**

important operation



Evolution Possibilities:

Like any creature of Earth, there are always room for improvement. Unlike evolution, it's up to you to design the CYBUG's improvement. Here are some thoughts on things you might improve on your CYBUG.

- Use pipe cleaners and other decorations to create legs and antennae for your new creature. You can attach these appendages to the CYBUG using hot glue, but be careful not to get glue in any components.
- Modify the feelers to detect edges as well as obstacles. This would require you add a small piece of wire across the bottom of the feeler sensor loop, which will contact the feeler wire as the feeler drops off the table.
- Add small plastic tubes to each photocell to improve directionality.
- Add bumpers and side guards from some brass wire to help the CYBUG avoid getting tangled up with other CYBUG's.

Schematic Diagram:

Visit <http://www.jcminventures.com> for a larger format version of this schematic.

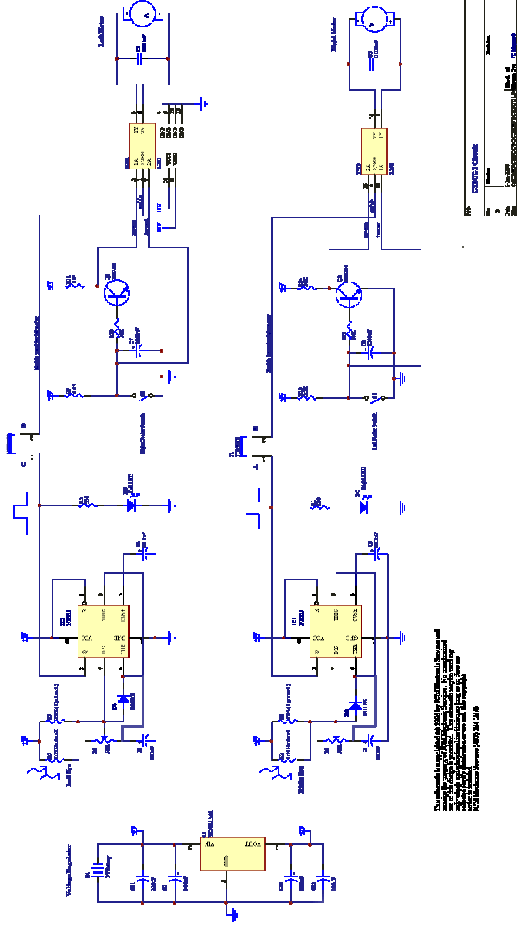

Copyright © 2003 JCM InVentures, Inc. All rights reserved. This document is the property of JCM InVentures, Inc. and is intended for use only by the individual user. No part of this document may be reproduced, stored in a retrieval system, or transmitted, in any form or by any means, without the prior written permission of JCM InVentures, Inc.

Attaching Charging Antennae to your CYBUG

Step 1: Buy a 0.008" steel guitar string wire from your local music shop and cut it into two 2.5" lengths. It is suggested you use an old pair of wire cutters because this wire is very hard and may nick your sidecutters. You might try bending it with pliers until it breaks as an alternative to cutting it.

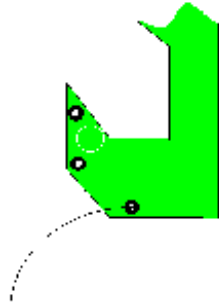

Step 2: At the front tips of the CYBUG's circuit board, just behind the feeler loops, you will notice two small empty pads.

Solder the short end of the guitar wire you prepared in step 1 to the outside pad on the left side. Cut off excess lead under the circuit board. Repeat on the right side of the CYBUG.

Step 3: Using two 10cm length of wire, attach the positive terminal of the 1F capacitor to each of the guitar string antennae.

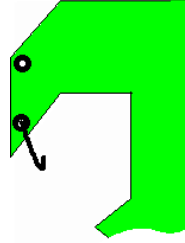

Step 4: Similarly, solder a guitar string about 2 inches long to the other pad and let it descend down make contact with the ground (See diagrams showing bottom view and side view). This will be the ground wiper.

Repeat for both sides.

Step 5: Adjust the wires so that the top wire touches the leaves and the bottom wire touches the aluminum foil when the CYBUG maneuvers up to the charging flower.

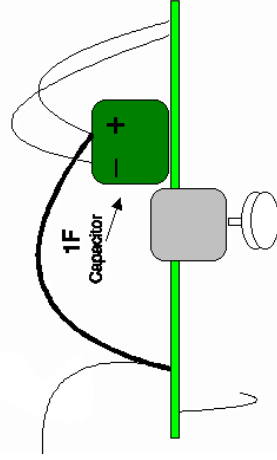

Step 6: The 1F capacitor replaces the conventional battery. Connect the positive and negative leads of the capacitor to the red and black battery input to the CYBUG.

It's Feeding Time! **Plug in the flower transformer and hold the CYBUG up to the plant so that the leaves touch the antennae and the ground foil touches the ground contact.** You may have to hold the CYBUG to the plant for a minute or so to allow the 1F capacitor to charge fully. When it looks like the robot has peaked in activity, set it down and let it explore it's environment.

you will perform while constructing this kit. A good solder connection will ensure a solid electrical connection between the part and the circuit board. A bad solder joint can prevent an otherwise well assembled kit from functioning properly.

It is simple to make a good solder connection if you follow a **few simple rules:**

1. Use the right type of soldering iron. A 25 to 40 Watt pencil type iron intended for electronic work with a 1/8" pointed tip works best. Use a rosin-core solder on diameter approximately 0.032" and a 60/40 lead/tin ratio.
2. Keep the soldering tip clean by wiping it frequently on a wet sponge or cloth: then apply solder to the tip to give the entire tip a *wet* look (tinning the tip). When solder tends to "ball" or does not stick to the tip, the tip needs to be cleaned and re-tinned.

How to Solder

- Install the component on the board, flaring the leads on bottom side slightly (so the part does not fall out when the board is flipped!) Flip the board upside down.
- Touch the freshly tinned soldering iron to the point where the component wire meets the board. Hold for 1 second!
- Touch the solder to the opposite side of the component wire/board junction and allow solder to melt and surround pad entirely.
- Remove the solder, then remove the soldering iron by dragging the iron up the component wire.
- Clip off excess component wire with side-cutters.

How do you know when you've made a good connection?

Too Much Solder? Solder will ball up like an igloo.

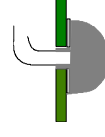

Too Little Solder? Solder will lie flat like a pancake.

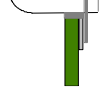

Just the right amount? Solder will look like a volcano!

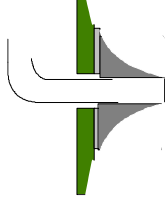

**Having a hard time?
Check out our website for a great soldering tutorial!**
<http://www.jcminventures.com>

Component Identification:

The function of all the components listed below are described in the assembly instructions. Please look through your kit and identify each component type!

Resistors will be described by their colour-code, a sequence of coloured bands which identify their resistance's. The colour lines are read from left to right with the gold or silver band being the right-most band. Resistance is measured in "ohms", frequently symbolized by the Greek ' Ω ' symbol.

- The first two bands identify the first two digits of the resistance value.
- The third band is the number of zero's (or multiplier)
- The fourth band indicates the tolerance of the resistor and is typically gold (5%) or silver (10%)

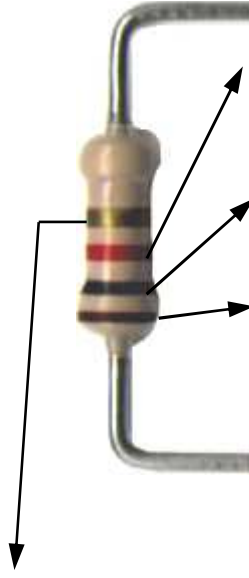

Colour	1 st Band	2 nd Band	3 rd Band
Black	0	0	No Multiplier
Brown	1	1	0
Red	2	2	00
Orange	3	3	000 (K)
Yellow	4	4	0000
Green	5	5	0,000
Blue	6	6	000,000 (M)
Violet	7	7	0,000,000
Gray	8	8	00,000,000
White	9	9	000,000,000

The resistor depicted above is a 1000 ohm resistor, or 1k Ω .

Capacitors will be called out by their capacitance value in μF (microfarads) or pF (picofarads) and type: monolithic or electrolytic. The larger electrolytic capacitors will have their values printed on them and have the **negative** lead marked with a large white stripe. The small monolithic capacitors will be labeled as 103 (1 $\times 10^3$ pF) or 102 (1 $\times 10^2$ pF) and have no polarity.

220 μF
Electrolytic
Capacitor



- +

Monolithic
Capacitor



Building a SUN-FLOWER feeding station

Step 1: Cut three or four large metallic leaves from the aluminum cookie sheets (About 15 cm long and 8 cm wide)

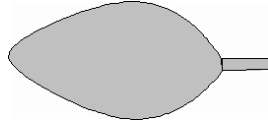

Step 2: Attach them to the stem of your artificial plant with twisted wire, zip-ties, or hot glue between 9 and 13 cm off the ground. These leaves should be in electrical contact with each other (touching). (Aluminum foil wrapped around the stem where the leaves attach may improve the conductivity between the leaves.) This will carry the charging current for the CYBUG

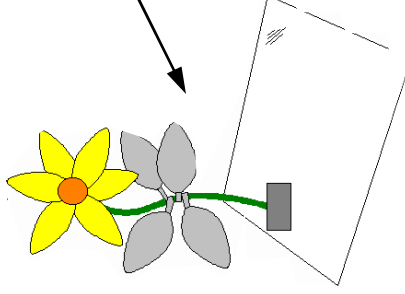

Support the SUNFLOWER in a vertical position using some type of weighted base.

Step 3: Lay a large sheet of aluminum foil flat on the ground all around the plant and tape the perimeter to the table top.

Step 4: Set the plant on the aluminum foil. This will act as the ground plane for the robot. Make sure the aluminum foil does not contact the leaves in any way!

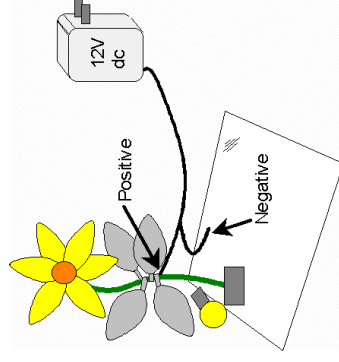

Step 5: Connect the positive lead of the transformer to the metallic leaves and the negative wire to the foil laying on the ground

Step 6: Connect the light bulb across the positive and negative leads from the transformer. Using hot-glue or tape, attach the light bulb near the base of the flower, under the leaves. It is this flower which will attract the CYBUG's

When the charger is plugged in, your robot will draw to the light bulb and be able to connect to the charging leaves and recharge some of it's expended energy! That is, once your robot has it's charging antennae attached and connected!



BUILDING A CYBUG FEEDER

Every bug needs a food source, and our young CYBUG is no exception. Whereas most insects draw energy from plant or animal matter, our robot requires a purer energy source.

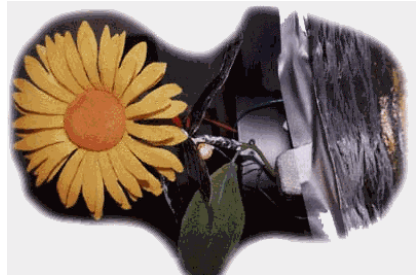

Diodes are similar in look to resistors. The diode type is printed directly on the package, and the negative lead or *cathode* is marked by a stripe on one end of the device. The other lead (positive) is called the *anode*. Diodes that emit light are called light-emitting diodes, or LEDs. The cathode of the LED is marked by a shorter lead and a notch in the LED case.

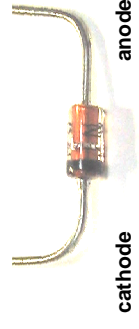

LEDs

Photocells are special resistors whose resistance value is controlled by the ambient light level. The photocells in this kit are made of Cadmium Sulphide, and are called Cds Photocells. Like resistors, Cds photocells have no polarity.

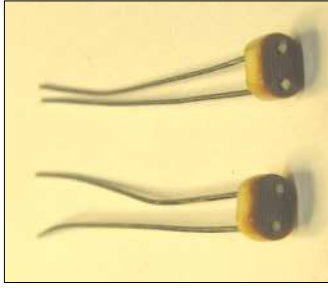

Potentiometers are another special type of resistor that can have their resistance value changed with the turn of a dial.

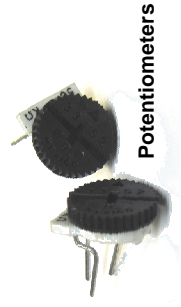

Potentiometers

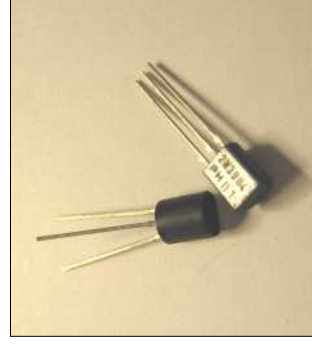

Transistors

Transistors look like faced-off cylinders with 3 legs, and their part number is printed on the face of the component body.

Item	Description	Sources
1	1F Memory backup capacitor (or larger)	ABRA electronics Part Number 555-1.4z5.5
2	Aluminum disposable cookie sheets	Most grocery stores or department stores where housewares are sold
3	12 volt dc wall adapter (800ma - 1000ma output)	Digi-key Part number T507-ND
4	12V Light bulb	Small automotive bulb
5	Artificial Plastic Plant, long stem, about 30 cm tall	Hobby or craft store
6	0.008" Steel guitar string	Any music store
7	Aluminum foil (Tin foil)	Most grocery stores or department stores where housewares are sold

Integrated Circuits will be called out by their part number, found printed on the top of their case. Pin numbers of the integrated circuits always start (1) with the top left pin and number counter-clockwise around the chip. The top of the chip is always identified with a dimple or notch.

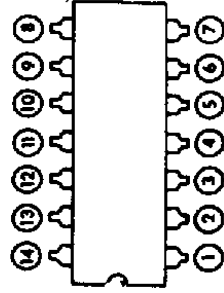
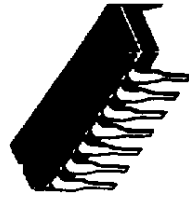

PARTS LIST

Take a moment to check that your kit contains all these components.

Quantity	Description	Check Off
2	330 ohm resistors	<input type="checkbox"/>
2	2.2k resistors	<input type="checkbox"/>
4	10k resistors	<input type="checkbox"/>
2	CdS Photocells	<input type="checkbox"/>
2	50K Potentiometers	<input type="checkbox"/>
5	103 (0.01uF) monolithic capacitors	<input type="checkbox"/>
2	47uF electrolytic capacitors	<input type="checkbox"/>
2	1000 uF electrolytic capacitors	<input type="checkbox"/>
2	Red LEDs	<input type="checkbox"/>
2	1n4148 diodes	<input type="checkbox"/>
1	NE555 timer integrated circuit	<input type="checkbox"/>
2	2n3904 transistors	<input type="checkbox"/>
1	L293 motor controller integrated circuit	<input type="checkbox"/>
1	14-Pin integrated circuit socket	<input type="checkbox"/>
1	16-Pin integrated circuit socket	<input type="checkbox"/>
2	DC motors	<input type="checkbox"/>
1	Printed circuit board	<input type="checkbox"/>
1	Length of thin steel wire	<input type="checkbox"/>
2	Glue-stick wheels	<input type="checkbox"/>
2	9V Battery Connectors (1 Male, 1 Female)	<input type="checkbox"/>
1	4-Pin Connector, Male	<input type="checkbox"/>
2	2-Pin Jumpers, Female	<input type="checkbox"/>
1	On/Off Switch	<input type="checkbox"/>

Bringing the CYBUG Scarab to life

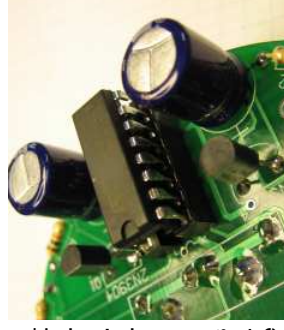

The first time you apply power to your first CYBUG Scarab, it may behave rather awkwardly. You will need to adjust it's behavior. The following adjustments should be performed in normal room light.

- () Press the integrated circuits into their sockets (556 in the head socket, L293 in the rear socket). Make sure the notches in the ICs match up to those in the silkscreen.
- () Install a 9V battery and turn the Scarab on. While watching LED D1, adjust potentiometer R7 until the LED is on for only ¼ the time that it is off (i.e. if it is off for 2 seconds, set the on time for roughly 0.5 seconds).
- () Repeat the previous task on R1 while watching LED D3.

By adjusting these potentiometer's settings you are controlling the activity level of your Scarab. Your creation may be a fast, energy consuming predatory creature, or a slow, deliberate herbivore.

TROUBLESHOOTING

If the following steps don't help there is a more detailed troubleshooting page on our website at <http://www.jcminventures.com>

Problem: My Scarab doesn't move at all! No lights, no nothing!

Sounds like he has an energy crisis. Is switch S1 in the on position? We suggest you check carefully that you have not attached the 9V battery connectors backwards. Perhaps your battery is simply low on power and needs to be replaced.

Problem: His LEDs light up and he moves, but he only backs up (or backs up on one side).

Your Scarab has one or both of his feelers touching the feeler sensor loop through which they pass. Carefully bend the lengths of feeler wire so that they pass directly through the loops, but don't touch the loop. If the feelers feel something, then they will touch the loop!

Problem: He moves OK, but his eye(s) aren't lighting up!

Chances are you have put his LEDs in backwards. Make sure the flat part on the base of the LED is facing the front of the Scarab.

Problem: Both motors go forward 100% of the time, and pay no attention to the light or obstacles.

This can happen if the 2-pin female jumpers are not installed beneath the 556 integrated circuit. Be sure that the two jumpers are in place as described on page 14 of this manual.

Still not working? Drop us an email at info@jcminventures.com

Please include top and bottom photos, if possible!



FABRICATION

We are almost ready to bring your Scarab to life, but first we must make a few final additions.

- () Turn your Scarab over and install the **female** 9V battery connector on the bottom of the board. This is the connector that will connect to the positive side of the 9V battery, so make sure the connector is installed **beneath the plus sign!** You may need to use some masking tape to get the connector to stand up straight.
- () Solder the female connector. Remember, since the connector goes on the bottom of the board, you'll be soldering from the top!
- () Make sure switch S1 is in the **off** position. Install the **male** 9V battery connector into the bottom of the board beside the female connector, and plug the battery into the connectors to hold the male connector in place.
- () Solder the male connector to the circuit board and remove the battery.

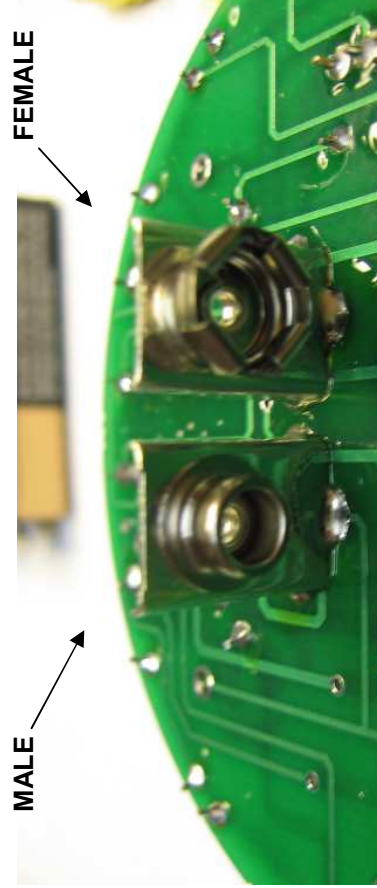
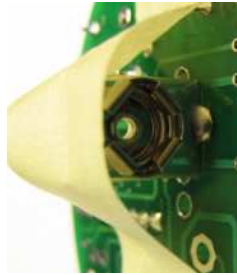

Now it's time to place wheels on your Scarab.

- () Using the tip of your soldering iron, melt a deep well into one side of one glue-stick wheel and press the wheel firmly onto the motor shaft. Try not to melt right through the wheel!
- () Attach the second glue-stick wheel to the other motor shaft. Make sure you clean the tip of your iron very well after this step.

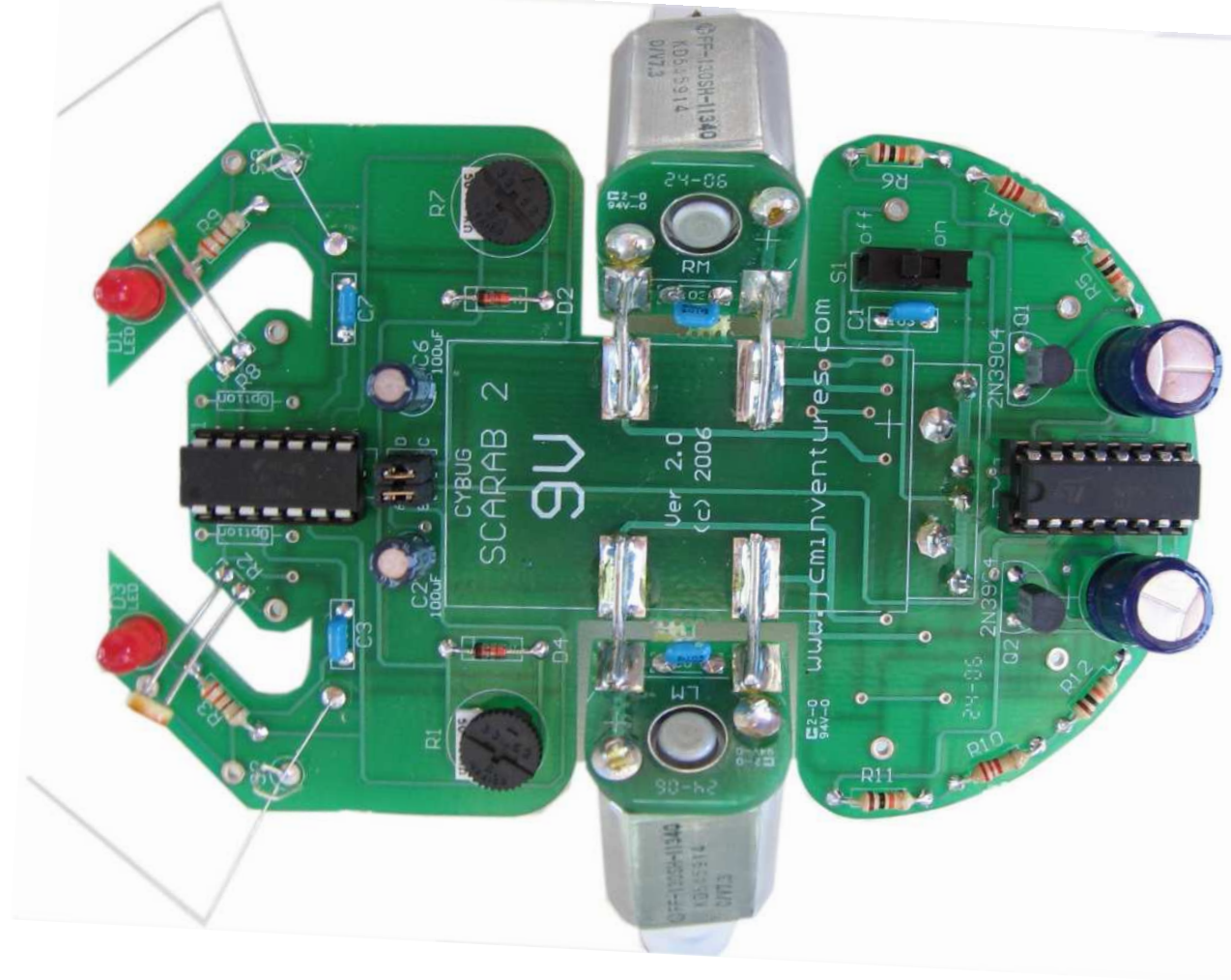
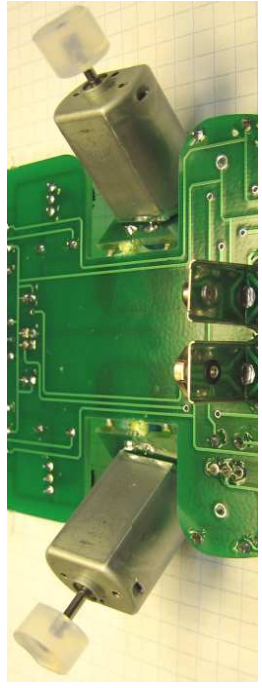

Use this picture as a reference or for taking notes while you are building your Scarab.



FABRICATION

Place the following resistors in the identified location. They should be flush with the circuit board. Flaring the leads slightly on the opposite side will help hold the parts in when the board is turned upside down for soldering. Note: Ω = ohms

Note: Parts are identified by a component number clearly marked on the circuit board and a description of the component.

Value	Colour code
<input checked="" type="checkbox"/> R3 - 330 Ω (orange orange brown gold)	

Component Designator on PCB

- () R1 - 50K Potentiometer (straighten the leads first!)
- () R3 - 330 Ω (orange orange brown gold)
- () R4 - 2.2K Ω (red red red gold)
- () R5 & R6 - 10K Ω (brown black orange gold)
- () R7 - 50K Potentiometer
- () R9 - 330 Ω (orange orange brown gold)
- () R10 - 2.2K Ω (red red red gold)
- () R11 & R12 - 10K Ω (brown black orange gold)

SAFETY WARNING: To avoid eye injury when you clip off excess leads, wear safety glasses!

For good solder connections, you must **keep the soldering iron tip clean**. Wipe it often on a wet sponge or cloth.

- () Solder the leads to the circuit board and cut off excess lead lengths.

NOTE: No lead should extend more than 1/8" above the circuit board after it has been soldered and cut off.

- () C2 & C6 - 47uF Electrolytic Capacitors (Watch the polarity!) These are marked 100uF on the circuit board, but work better with 47uF capacitors.
- () C4 & C8 - 1000uF Electrolytic capacitors (Watch polarity!)

NOTE: The label 103 on the monolithic capacitors refers to 10×10^3 pF or 0.01×10^{-6} farads (0.01 uF) There is no polarity on this part.

- () C3 & C7 - 0.01uF (103) capacitors (small yellow or blue beads)
- () C5 & C9 - 0.01uF (103) capacitors (by the motors)
- () C1 - 0.01uF (103) capacitor (near the power switch)
- () Solder the leads to the circuit board and cut off excess lead lengths. If some components have trouble staying flush to the board during soldering... use some masking tape!

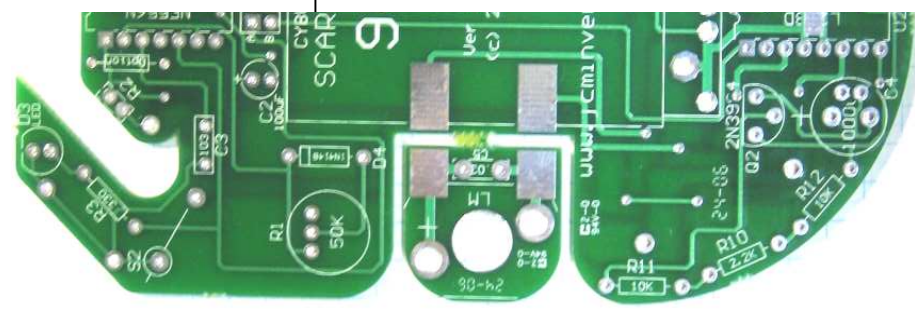

THEORY

You are creating two very sensitive switches which will be used by your Scarab to detect objects and other CYBUGs immediately in front.

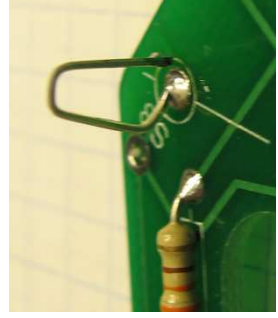

The thin wires which extend to the front are connected on the circuit board to ground. From there they pass through a loop of wire which is connected to an input to the robot's nervous system.

When the long feeler wire bumps an object it will bend backwards (or forwards) and touch the sides of the feeler loop. When this happens, the robot reacts by backing away.

For this reason, it is very important that the feeler wires are gently adjusted until they pass through the center of the wire loop without actually touching the loop itself.

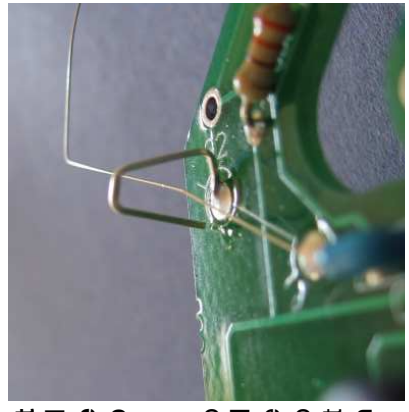

You may find that if your CYBUG Scarab vibrates too much in motion the feelers will wobble enough to cause them to touch the sensor loops, making the CYBUG Scarab believe it has bumped something, making it spin backwards. Try centering the feeler in the sensor loop better if this happens.

- () Install the power switch into S1 (beside C1). This device has no polarity.

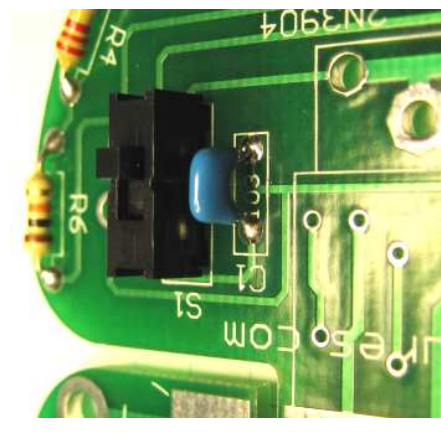
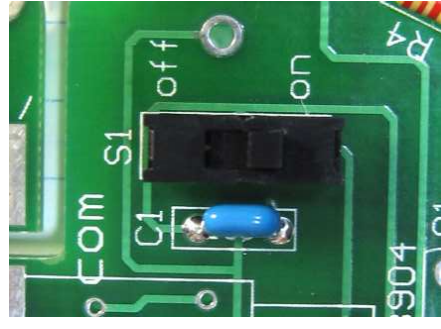

FABRICATION

This part of the exercise creates the feelers which our Scarab depends upon for avoiding obstacles.

- () Create two small sensor loops using the leads of resistors or capacitors that you have already cut off. These are easy to create by wrapping the wire fully around a pair of pliers, leaving a small amount sticking out.
- () Solder these small sensor loops into **S2** and **S3** (surrounded by silkscreen rings).
- () Prepare the *feelers* by cutting the thin steel guitar-string wire in half.
- () Solder one end of each wire into the pad attached to S2 and S3 by a silkscreen line (the pads immediately beside C3 and C7).

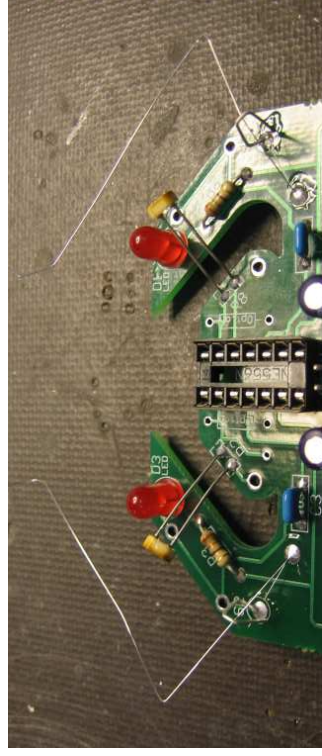

- () Pass the other end of each feeler wire through the sensor loop (make sure it floats in the center of the loop), then bend the wires so they come around to the front of the Scarab and cut off any excess length.

- () Take the 4-pin connector and break it in half. Solder each 2-pin connector into the pads marked A, B, C and D.

- () Here's your chance to choose whether you want our Scarab to be light-seeking (phototropic) or light-avoiding (photophobic)! If you want a **phototropic** Scarab, place one jumper from A to B and one jumper from C to D. If you want a **photophobic** Scarab, place one jumper from A to D and one jumper from B to C.

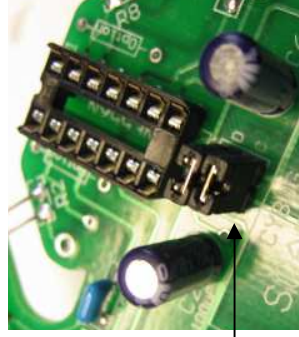
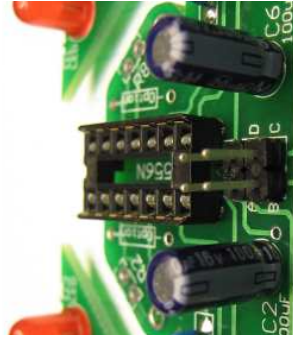

This one is set up to be **photophobic**.
What a *scaready-bug!*

THEORY

In this section we are installing the resistors and capacitors in our Scarab.

The resistors are used to limit flow of current in the circuit, much as a pinched garden hose would limit the amount of water flowing through the hose.

Resistors R1 through R12 are effecting the size of the pulse sent to the motors by controlling the current flowing into the 556 timer (U1). These motor pulses control the size of the steps of the left and right motors.

R1 and R7 are adjustable resistors called *potentiometers*. The resistance of these components may be adjusted by simply turning the dial.

The components C1 through C8 are called *capacitors*. These are energy storage devices, rather like small rechargeable batteries. They can be used for many functions:

- **C1** smoothes any ripples in Scarab's voltage.
- **C5 and C9** remove voltage spikes caused by the motors.
- **C4 and C8** act as a kind of memory, making sure that the Scarab backs up for about 1 second when a feeler is touched.

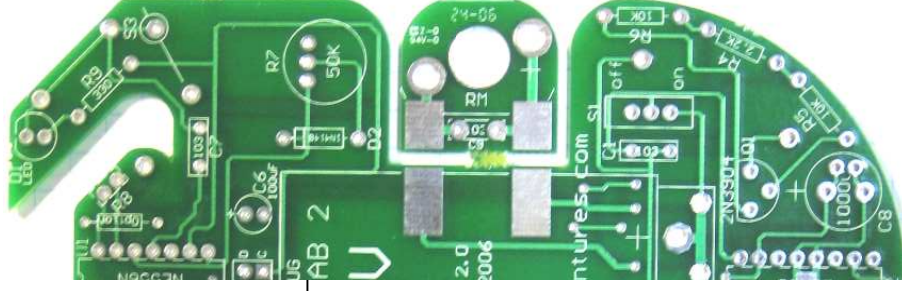



FABRICATION

This part of the fabrication involves mounting the semi-conductors onto the Scarab. **Please note:** All these components are polarity sensitive, and will be damaged if they are put in upside down. *Please heed all directions!*

Diodes have polarity! The black bar on the diode is the negative end, and must align with the white line on the printed circuit board.



() D2 & D4 - 1N4148 Diodes Small orange glass component

When installing LEDs, watch the polarity! The negative side is the side with the slightly shorter lead and the plastic base of the LED has a **slight flat impression**. These must line up with the flat line marking on the printed circuit board.

() D1 & D3 - Red LEDs. Mount these flush to the circuit board. (Watch the Polarity!)

Integrated circuits pressed into sockets must be installed with the notch on the top of the plastic case aligned with the notch on the silkscreen.

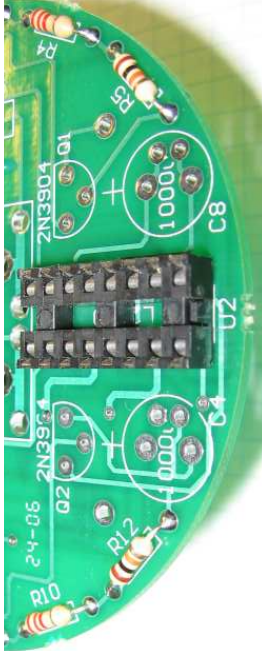

() U1 & U2 - Install Sockets for integrated circuits. Do not solder the integrated circuits directly into the circuit board... the integrated circuits will be pressed into these sockets later.



() R2 & R8 - Install Photocells. Leave about 1/2 inch of lead on these devices and point them slightly outward from the body of the CYBUG.

When installing the transistors line up the flat side of the plastic case with the line on the white silkscreen.

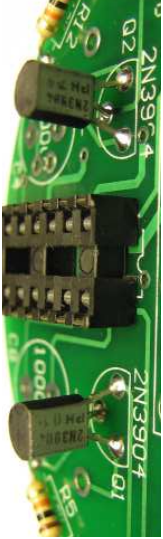

() Q1 & Q2 - Install 2n3904 transistors.

() Solder the leads to the circuit board



THEORY

The motors we are about to add to our electronic life-form will convert electrical energy from the battery into rotational energy on the motor shaft.

- The motor uses two very important physical laws:
- Current flow through a wire generates a magnetic field whose strength is proportional to the amount of current.
 - Like poles of magnets repel, and unlike poles attract.

A motor works by employing a rotating central armature wrapped with wire to produce and electric field. Current is fed to this rotating armature by a pair of brushes touching a commutator. The entire armature and commutator assembly spins within a set of permanent magnets. When current is passed through the armature of a DC motor, a torque is generated by magnetic reaction, and the armature revolves. **

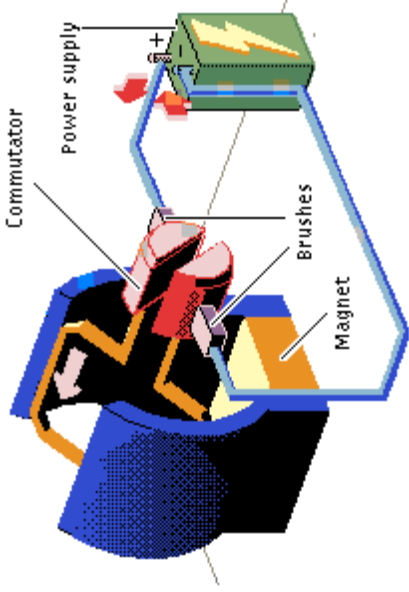

() Break the motor boards away from the Scarab's body and bend upwards at about a 45 degree angle.



**Electric motors and generators," Microsoft® Encarta © 96 Encyclopedia. © 1993-1995 Microsoft Corporation. All rights reserved.



FABRICATION

This section details the installation of the Scarab's motors.

- () Cut four 5/8" lengths from the heavy gauge bus-bar wire from your kit. These will be used to hold the smaller motor boards to the Scarab's body, as well as to provide power for the motors!
- () Place one length of wire across two pads as shown below. Tape one side of the wire to the board with masking tape, and solder the other side to the metallic pad. Use **LOTS** of solder here, we need a strong mechanical and electrical bond.

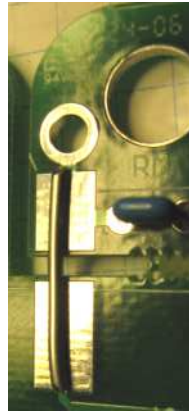

- () Remove the masking tape and solder the other side of the wire to the board. Repeat for the remaining 3 wires.



When installing the DC motors, *watch the polarity!* The positive motor terminal is marked with a **red dot**, and should be installed on the side of the motor board with the plus (+) sign.

- () Install one DC motor in its motor board from the bottom side, and solder both terminals into place. Make sure you use lots of solder here too! Repeat for the second motor. If you've installed the motors correctly, the motor labels will be facing out!

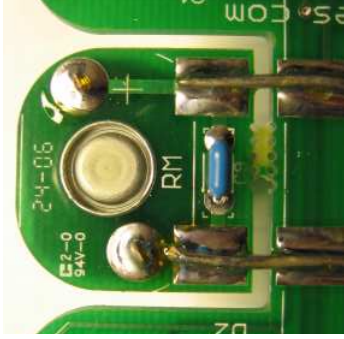
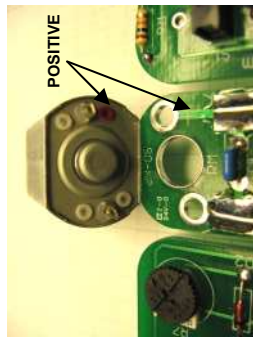

THEORY



Semiconductors are very special electronic components which are based on silicon. With these devices we may:

- turn current on and off
- amplify small signals to large signals
- act as a one-way valve for current

A diode, such as this 1N4148, is an electronic back-flow preventer! Electrons may only flow in one direction through this component, but not the other!

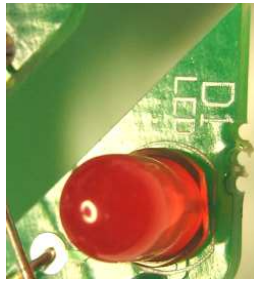

LEDs (Light Emitting Diodes) are also diodes, but are specially prepared with a glowing phosphor which lights bright red when current flows. Remember: if you put this diode in backwards no current will flow, so it won't light!

Integrated Circuits are small in stature but big in performance! Each one has hundreds or thousands of diodes and transistors inside and may perform very advanced functions! The 14-pin 556 timers are producing small electrical pulses to signal the motors to spin.



The L293 (U1) is an integrated circuit chip which has a high current output suitable for powering motors.

PhotoCells (R2 & R8) are resistors which are sensitive to light. The brighter the light, the lower the resistance! Our CYBUG uses these parts as it's eye's. The photocell with the brightest light causes will cause one half of the 556 timer chip to reduce the energy it sends to the motor, causing that motor to slow. Our CYBUG will turn toward that bright light!

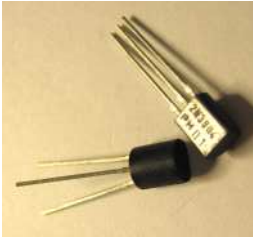

Transistors (Q1 and Q2) may be used to turn on and off electronic current much the same as a kitchen faucet can control the amount of water. These transistors are involved in telling the CYBUG to back-up when it's feelers touch an object.



Use this photo as a reference while building your Scarab!

